

PRODUCT DATA SHEET

Part number 10140

EAN 4015609003877

Manufacturer WALTHER-WERKE

WEEE-Reg.-Number: DE 22131895

Product description

NORVO wall socket for external fixing 16A 3P 0h for low voltage with one PG21 top cable entry and two PG16 bottom cable entries



Similar image

Detailed product description

WALTHER Wall socket 16A 3P 24V 0h IP44
 low-voltage connector from the NORVO series
 made from PA6 material
 in purple
 with one PG21 top cable entry
 and two PG16 bottom cable entries
 for external fixing
 outer dimensions 93x90mm

Ordering Information

Order unit	Piece
Customs number	85366990
Net weight	0,224 kg
Packing quantity (VPE)	10
Length of the packaging	0,31 m
Width of the packaging	0,195 m
Depth of the packaging	0,14 m
Gross weight(VPE)	2,388 kg

Classification system

Classification system	ETIM_6.0
ETIM Class	EC001321

Technical product data

Model	Surface mounted (plaster)
IEC-amperage	16 A
Amperage acc. UL/CSA (for UL-version)	20 A
Number of poles	3
Voltage acc. EN 60309-2	20-25 V (50+60 Hz) violet
Clock hour position	0 h
Identification colour	Violet (lilac)
Degree of protection (IP)	IP44
Connection system	Screwed terminal
Material	Plastic
Type of fastening	External mounting
Insulated mounting	True

Dimension sheet

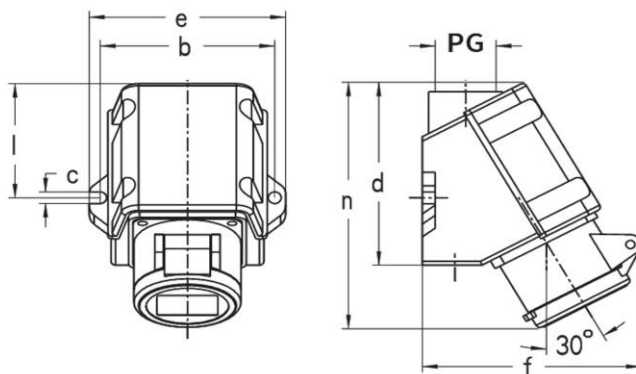

Amp.	16		32	
Pole	2	3	2	3
b	80	80	80	80
c	6,2	6,2	6,2	6,2
d	93	93	93	93
e	90	90	90	90
f	93	93	93	93
l	60	60	60	60
n	125	125	125	125