

PRODUCT DATA SHEET

Part number	10154
EAN	4015609003976
Manufacturer	WALTHER-WERKE
WEEE-Reg.-Number:	DE 22131895

Product description

NORVO wall socket for external fixing 16A 3P 3h for low voltage with one top cable entry



[Similar image](#)

Detailed product description

WALTHER Wall socket 16A 3P 42V 3h IP44
 low-voltage connector from the NORVO series
 made from PA6 material
 in purple
 with one top cable entry
 for external fixing
 outer dimensions 81x70mm

Ordering Information

Order unit	Piece
Customs number	85366990
Net weight	0,18 kg
Packing quantity (VPE)	10
Length of the packaging	0,31 m
Width of the packaging	0,195 m
Depth of the packaging	0,14 m
Gross weight(VPE)	1,948 kg

Classification system

Classification system	ETIM_6.0
ETIM Class	EC001321

Technical product data

Model	Surface mounted (plaster)
IEC-amperage	16 A
Amperage acc. UL/CSA (for UL-version)	20 A
Number of poles	3
Voltage acc. EN 60309-2	20-25 V / 40-50 V (400 Hz) green
Clock hour position	3 h
Identification colour	Green
RAL-number	6025
Degree of protection (IP)	IP44
Connection system	Screwed terminal
Material	Plastic
Type of fastening	External mounting
Insulated mounting	True

Dimension sheet

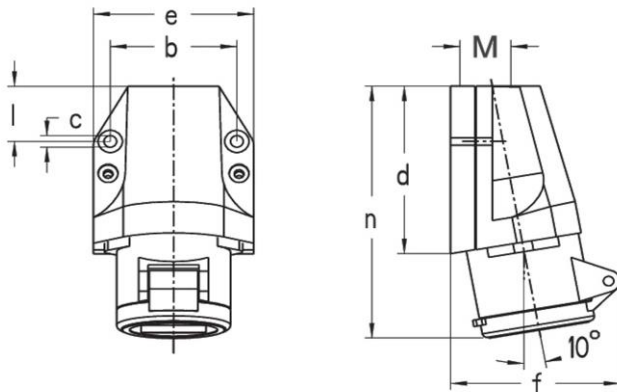

Amp.	16		32	
	2	3	2	3
b	54,5	54,5	54,5	54,5
c	5,2	5,2	5,2	5,2
d	81	81	81	81
e	70	70	70	70
f	72	72	72	72
l	28	28	28	28
n	119	119	119	119
M	25	25	25	25