

## PRODUCT DATA SHEET

---

Part number	11101
EAN	4015609005758
Manufacturer	WALTER-WERKE
WEEE-Reg.-Number:	DE 22131895

### Product description

---

NORVO wall socket for external fixing 32A 2P 12h for low voltage with one PG21 top cable entry and two PG16 bottom cable entries



Similar image

### Detailed product description

---

WALTER Wall socket 32A 2P 42V 12h IP44  
 low-voltage connector from the NORVO series  
 made from PA6 material  
 in purple  
 with one PG21 top cable entry  
 and two PG16 bottom cable entries  
 for external fixing  
 outer dimensions 93x90mm

### Ordering Information

---

Order unit	Piece
Customs number	85366990
Net weight	0,213 kg
Packing quantity (VPE)	10
Length of the packaging	0,31 m
Width of the packaging	0,195 m
Depth of the packaging	0,14 m
Gross weight(VPE)	2,278 kg

## Classification system

Classification system	ETIM_6.0
ETIM Class	EC001321

## Technical product data

Model	Surface mounted (plaster)
IEC-amperage	32 A
Amperage acc. UL/CSA (for UL-version)	30 A
Number of poles	2
Voltage acc. EN 60309-2	40-50 V (50+60 Hz) white
Clock hour position	12 h
Identification colour	White
Degree of protection (IP)	IP44
Connection system	Screwed terminal
Material	Plastic
Type of fastening	External mounting
Insulated mounting	True

## Dimension sheet

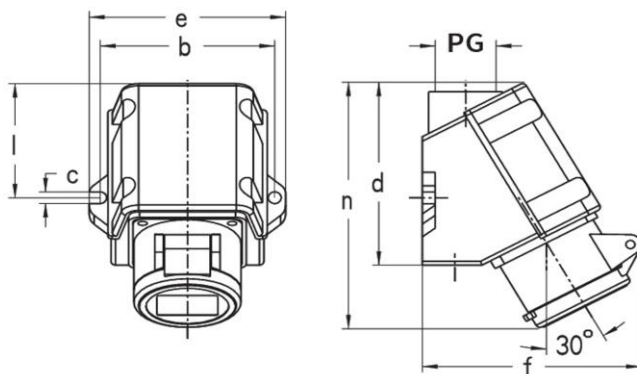

Amp.	16		32	
Pole	2	3	2	3
b	80	80	80	80
c	6,2	6,2	6,2	6,2
d	93	93	93	93
e	90	90	90	90
f	93	93	93	93
l	60	60	60	60
n	125	125	125	125