

PRODUCT DATA SHEET

Part number 11353

EAN 4015609006755

Manufacturer WALTHER-WERKE

WEEE-Reg.-Number: DE 22131895

Product description

NORVO coupler 32A 3P 2h for low voltage with cable gland, PG 16



Similar image

Detailed product description

WALTHER Coupler 32A 3P 42V 2h IP44
 low-voltage connector from the NORVO series
 made from PA6 material
 in purple

Ordering Information

Order unit	Piece
Customs number	85366990
Net weight	0,158 kg
Packing quantity (VPE)	10
Length of the packaging	0,31 m
Width of the packaging	0,195 m
Depth of the packaging	0,14 m
Gross weight(VPE)	1,728 kg

Classification system

Classification system	ETIM_6.0
ETIM Class	EC001320

Technical product data

IEC-amperage	32 A
Amperage acc. UL/CSA (for UL-version)	30 A
Number of poles	3
Voltage acc. EN 60309-2	20-25 V / 40-50 V (300 Hz) green
Clock hour position	2 h
Identification colour	Green
RAL-number	6025
Degree of protection (IP)	IP44
Connection system	Screwed terminal
Angle of plug	Straight
Cable entry	Swivel
Material	Plastic

Dimension sheet

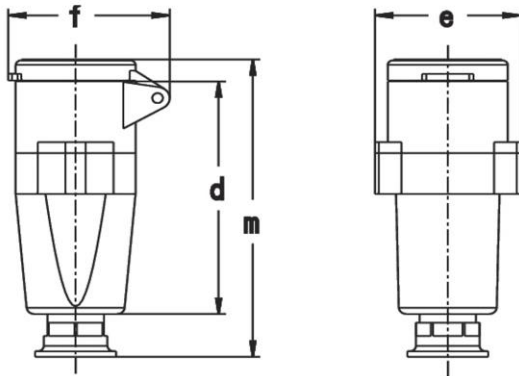

Amp.	16		32	
Pole	2	3	2	3
d	143	143	143	143
e	59	59	59	59
f	67	67	67	67
m	104	104	104	104
Øp	7,5 - 14,5			