

## PRODUCT DATA SHEET

---

Part number 11383

---

EAN 4015609006878

Manufacturer WALTHER-WERKE

WEEE-Reg.-Number: DE 22131895

### Product description

---

NORVO coupler 32A 2P 2h for low voltage with grommet



Similar image

### Detailed product description

---

WALTHER Coupler 32A 2P 42V 2h IP44  
 low-voltage connector from the NORVO series  
 made from PA6 material  
 in purple  
 with grommet

### Ordering Information

---

Order unit	Piece
Customs number	85366990
Net weight	0,15 kg
Packing quantity (VPE)	10
Length of the packaging	0,31 m
Width of the packaging	0,195 m
Depth of the packaging	0,14 m
Gross weight(VPE)	1,648 kg

### Classification system

---

Classification system ETIM\_6.0

ETIM Class

EC001320

### Technical product data

IEC-amperage	32 A
Amperage acc. UL/CSA (for UL-version)	30 A
Number of poles	2
Voltage acc. EN 60309-2	20-25 V / 40-50 V (300 Hz) green
Clock hour position	2 h
Identification colour	Green
RAL-number	6025
Degree of protection (IP)	IP44
Connection system	Screwed terminal
Angle of plug	Straight
Cable entry	Anti-kink sleeve
Material	Plastic

### Dimension sheet

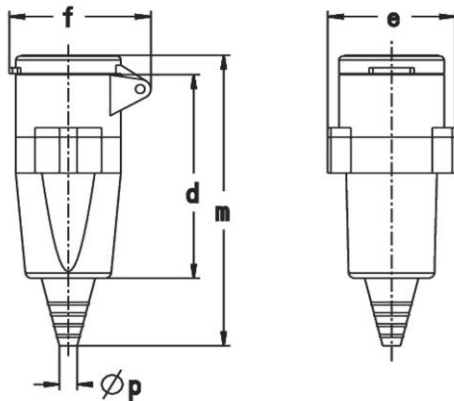

Amp.	16		32	
	2	3	2	3
d	150	150	150	150
e	59	59	59	59
f	67	67	67	67
m	104	104	104	104
Øp	8/21	8/21	8/21	8/21