

PRODUCT DATA SHEET

Part number 115306

EAN 4015609009817

Manufacturer WALTHER-WERKE

WEEE-Reg.-Number: DE 22131895

Product description

MiniKombi wall socket 16A 3P 6h with fused Schuko socket, two cable entries both top and bottom and one knock-out floor entry



Similar image

Detailed product description

WALTHER Mini-combination 16A 3P 230V 6h IP44

CEE-type wall socket

with Schuko socket 16A, 230V, 2P+E IP44

made from PA6 material

with screw terminal

with two cable entries both top and bottom

and one knock-out floor entry

Schuko socket with fuse 6.3 A G, 5x20mm

Ordering Information

Order unit	Piece
Customs number	85366990
Net weight	0,4748 kg
Packing quantity (VPE)	5
Length of the packaging	0,31 m
Width of the packaging	0,255 m
Depth of the packaging	0,15 m
Gross weight(VPE)	2,57 kg

Classification system

Classification system	ETIM_6.0
ETIM Class	EC001321

Technical product data

Model	Surface mounted (plaster)
IEC-amperage	16 A
Amperage acc. UL/CSA (for UL-version)	20 A
Number of poles	3
Voltage acc. EN 60309-2	230 V (50+60 Hz) blue
Clock hour position	6 h
Identification colour	Blue
RAL-number	5002
Degree of protection (IP)	IP44
Connection system	Screwed terminal
Material	Plastic
Type of fastening	Inner lying mounting
Insulated mounting	True

Dimension sheet

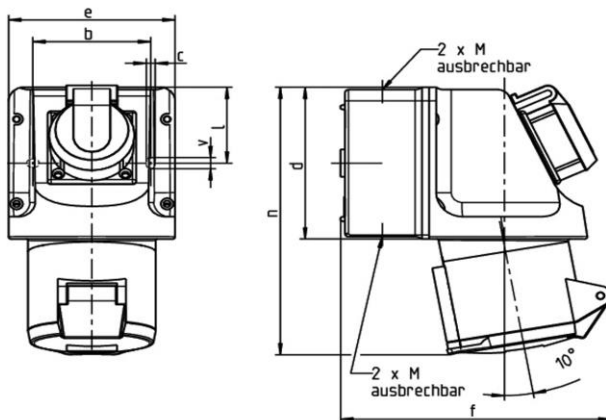

Amp.	16		32	
Pole	3	5	3	5
b	66,5	66,5	66,5	66,5
c	5	5	5	5
d	96	96	96	96
e	95	95	95	95
f	140	146	154	157
l	47,5	47,5	47,5	47,5
n	160	164	173	173
v	7	7	7	7
M	20/25	20/25	20/25	20/25