

## PRODUCT DATA SHEET

---

Part number 11803

---

EAN 4015609007431

Manufacturer WALTHER-WERKE

WEEE-Reg.-Number: DE 22131895

### Product description

---

NORVO appliance inlet for external fixing 32A 2P 2h for low voltage with one top cable entry



Similar image

### Detailed product description

---

WALTHER appliance inlet 32A 2P 42V 2h IP44  
 low-voltage connector from the NORVO series  
 made from PA6 material  
 in purple  
 with one top cable entry  
 for external fixing  
 outer dimensions 81x80mm

### Ordering Information

---

Order unit	Piece
Customs number	85366990
Net weight	0,128 kg
Packing quantity (VPE)	10
Length of the packaging	0,31 m
Width of the packaging	0,195 m
Depth of the packaging	0,14 m
Gross weight(VPE)	1,428 kg

### Classification system

---

Classification system	ETIM_6.0
ETIM Class	EC001319

### Technical product data

IEC-amperage	32 A
Amperage acc. UL/CSA (for UL-version)	30 A
Number of poles	2
Voltage acc. EN 60309-2	20-25 V / 40-50 V (300 Hz) green
Clock hour position	2 h
Identification colour	Green
RAL-number	6025
Degree of protection (IP)	IP44
Connection system	Screwed terminal
Connection type	Wall mounted plug
Angle of plug	Angled
Material	Plastic

### Dimension sheet

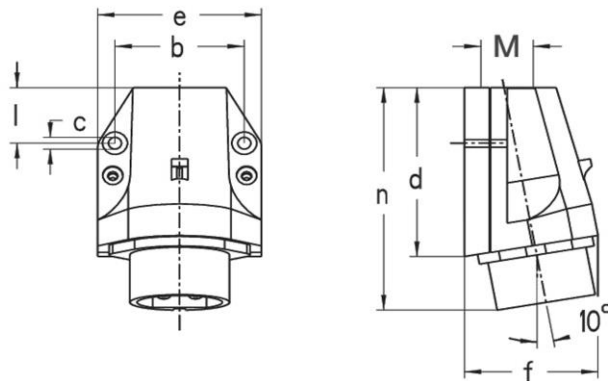

Amp.	16		32	
Pole	2	3	2	3
b	54,5	54,5	54,5	54,5
c	5,2	5,2	5,2	5,2
d	81	81	81	81
e	70	70	70	70
f	68	68	68	68
l	28	28	28	28
n	105	105	105	105
M	25		25	