

## PRODUCT DATA SHEET

---

Part number **163504**

EAN	4015609251179
Manufacturer	WALTHER-WERKE
WEEE-Reg.-Number:	DE 22131895

### Product description

---

Wall socket for internal fixing 63A 5P 4h with two top cable entries and two knock-out bottom cable entries



Similar image

### Detailed product description

---

WALTHER Wall socket 63A 5P 110V 4h IP44  
 made from PA6 material  
 for internal fixing  
 with two top cable entries  
 and two knock-out bottom cable entries

### Ordering Information

---

Order unit	Piece
Customs number	85366990
Net weight	1,9 kg
Packing quantity (VPE)	1
Length of the packaging	
Width of the packaging	
Depth of the packaging	
Gross weight(VPE)	1,9 kg

### Certificates

---

VDE certification **40000707**



UL certification

No. E188992



EAC certification

BY112.02.01.020 06089



## Classification system

Classification system

ETIM\_6.0

ETIM Class

EC001321

## Technical product data

Model	Surface mounted (plaster)
IEC-amperage	63 A
Amperage acc. UL/CSA (for UL-version)	60 A
Number of poles	5
Voltage acc. EN 60309-2	110 V (50+60 Hz) yellow
Clock hour position	4 h
Identification colour	Yellow
RAL-number	1018
Degree of protection (IP)	IP44
Connection system	Screwed terminal
Material	Plastic
Type of fastening	Inner lying mounting
Insulated mounting	True

## Dimension sheet

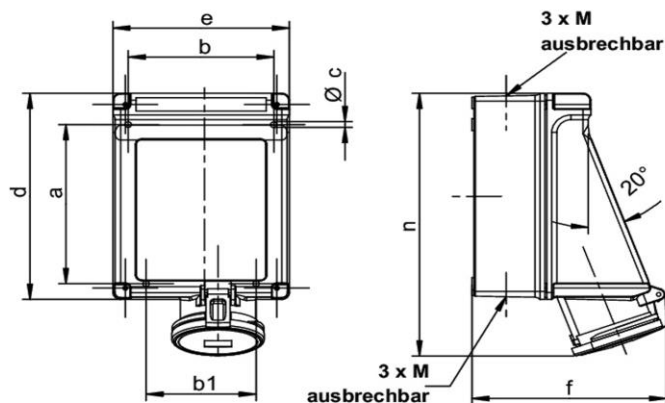

Amp.	63		
Pole	3	4	5
a	183	183	183
b	151	151	151
b1	114	114	114
c	6,5	6,5	6,5
d	237	237	237
e	183	183	183
f	196	196	196
n	302	302	302
M	25/32/40	25/32/40	25/32/40