

PRODUCT DATA SHEET

Part number 169304

EAN 4015609173655

Manufacturer WALThER-WERKE

WEEE-Reg.-Number: DE 22131895

Product description

Waterproof wall socket for internal fixing 63A 3P 4h with top cable entry and two knock-out bottom cable entries, rotatable base



Product Image

Detailed product description

WALThER Wall socket 63A 3P 110V 4h IP67
 made from PA6 material
 for internal fixing
 one open top cable entry
 and two knock-out bottom cable entries
 base rotatable by 180 degrees

Ordering Information

Order unit	Piece
Customs number	85366990
Net weight	0,865 kg
Packing quantity (VPE)	2
Length of the packaging	
Width of the packaging	
Depth of the packaging	
Gross weight(VPE)	1,73 kg

Certificates

VDE certification

40000707



EAC certification

BY112.02.01.020 06089



Classification system

Classification system

ETIM_6.0

ETIM Class

EC001321

Technical product data

Model	Surface mounted (plaster)
IEC-amperage	63 A
Amperage acc. UL/CSA (for UL-version)	60 A
Number of poles	3
Voltage acc. EN 60309-2	110 V (50+60 Hz) yellow
Clock hour position	4 h
Identification colour	Yellow
RAL-number	1018
Degree of protection (IP)	IP67
Connection system	Screwed terminal
Material	Plastic
Type of fastening	Inner lying mounting
Insulated mounting	True

Dimension sheet

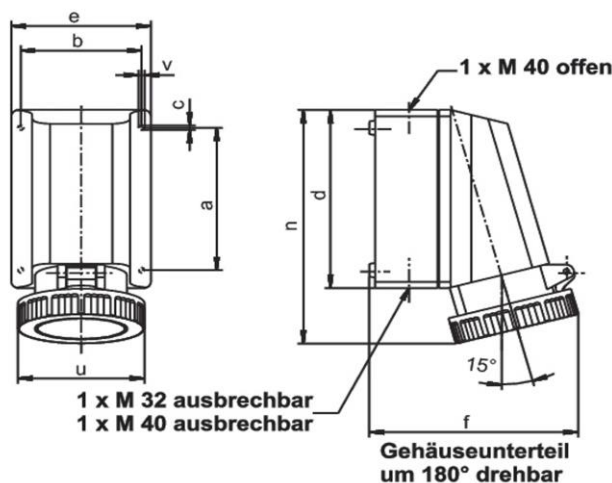

Amp.	63		
Pole	3	4	5
a	136	136	136
b	104	104	104
c	4,2	4,2	4,2
d	172	172	172
e	121	121	121
f	178	178	178
n	224	224	224
v	5	5	5