

## PRODUCT DATA SHEET

---

Part number 231409

---

EAN 4015609013869

Manufacturer WALTHER-WERKE

WEEE-Reg.-Nr: DE 22131895

### Product description

---

Plug 32A 4P 9h with cable gland



Product Image

### Detailed product description

---

WALTHER Plug 32A 4P 230V 9h IP44

made from PA6 material

with screw terminal

and cable gland

Increased safety due to injected 2K seal and two contact screws.

### Ordering information

---



order unit	Piece
customs number	85366990
net weight	0.217 kg
packing quantity (VPE)	10
length of the packaging	0.31 m
width of the packaging	0.195 m
depth of the packaging	0.14 m
gross weight(VPE)	2.318 kg

### Conformities

---

CE conformity	v
RoHS directive	2011/65/EU
RoHS directive	2015/863/EU
REACH regulation	1907/2006

## Certification

VDE/ENEC certification	40021520	
UL certification	No. E329476	
EAC certification	BY112.02.01.020 06090	

## Classification system

classification system	ETIM_7.0
ETIM Class	EC000140

## Technical product data

IEC-amperage	32 A
Amperage according to UL/CSA (for UL-version)	30 A
Number of poles	4
Voltage according to EN 60309-2	230 V (50+60Hz) blue
Clock hour position	9 h
Identification colour	Blue
Conductor cross-section	2.5 - 6 mm <sup>2</sup>
Cable diameter	10 - 19.5 mm
Cable strip length	45 mm +/- 2.5 mm
Cable ferrules length	10 mm +/- 1 mm
Maximum torque terminal screw	0.8 Nm
Maximum torque cable gland	4 Nm
Degree of protection (IP)	IP44
Connection system	Screwed terminal
Contact material	Brass standard
Cable entry	Swivel
Angle of plug	Straight
Material	Plastic
Inflammability class of insulation material according to with UL94	V2

## Dimension sheet

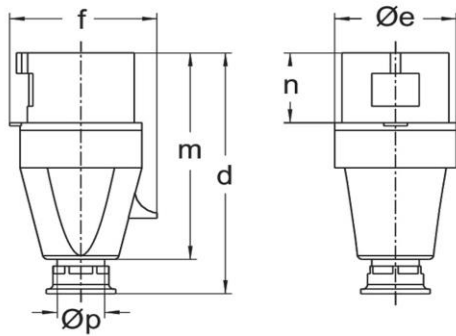

Amp.	16			32			63		
Pole	3	4	5	3	4	5	3	4	5
d	123	131	131	155	155	155	240	240	240
Øe	51	65	65	73	73	73	81	81	81
f	60	68	75	79	79	88	97	97	97
m	118	112	112	133	133	133	192	192	192
n	37	37	37	46	46	46	67	67	67
Øp	7,5-14,5	7,5-14,5	7,5-14,5	10-19,5	10-19,5	10-19,5	18-34,5	18-34,5	18-34,5