

PRODUCT DATA SHEET

Part number 262304

EAN 4015609665372

Manufacturer WALTHER-WERKE

WEEE-Reg.-Nr: DE 22131895

Product description

Plug 63A 3P 4h with external cable gland



Product Image

Detailed product description

WALTHER Plug 63A 3P 110V 4h IP44

- made from PA6 material
- with screw terminal
- with external cable gland
- and pilot contact



Ordering information

order unit	Piece
customs number	85366990
net weight	0.453 kg
packing quantity (VPE)	5
length of the packaging	0.31 m
width of the packaging	0.195 m
depth of the packaging	0.14 m
gross weight(VPE)	2.413 kg

Conformities

CE conformity	√
RoHS directive	2011/65/EU
RoHS directive	2015/863/EU
REACH regulation	1907/2006

Certification

VDE certification	40000693	
EAC certification	BY112.02.01.020 06090	

Classification system

classification system	ETIM_7.0
ETIM Class	EC000140

Technical product data

IEC-ampereage	63 A
Number of poles	3
Voltage according to EN 60309-2	110 V (50+60 Hz) yellow
Clock hour position	4 h
Identification colour	Yellow
Conductor cross-section	6 - 16 mm ²
Cable diameter	14 - 33 mm
Cable strip length	60 mm +/- 2.5 mm
Cable ferrules length	12 mm +/- 1 mm
Maximum torque terminal screw	2 Nm
Maximum torque back shell	2.5 Nm
Maximum torque cable gland	4 Nm
Maximum torque strain relief	3 Nm
Degree of protection (IP)	IP44
Connection system	Screwed terminal
Contact material	Brass standard
Cable entry	Swivel
Angle of plug	Straight
Material	Plastic
Inflammability class of insulation material according to with UL94	V2

Dimension sheet

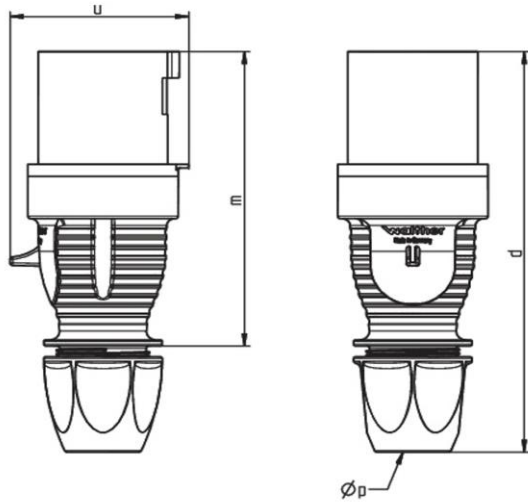

Amp.	63		
Pole	3	4	5
d	246	246	246
u	95	95	95
m	174	174	174
Øp	14-33	14-33	14-33