

## PRODUCT DATA SHEET

---

Part number 310406SL

---

EAN 4015609559879

Manufacturer WALTHER-WERKE

WEEE-Reg.-Number: DE 22131895

### Product description

---

Coupler 16A 4P 6h screwless and with external cable gland



Similar image

### Detailed product description

---

WALTHER Coupler 16A 4P 400V 6h IP44  
 made from PA6 material  
 screwless  
 with insulation displacement technique  
 and external cable gland  
 Increased safety due to injected 2K seal.



### Ordering Information

---

Order unit	Piece
Customs number	85366990
Net weight	0,261 kg
Packing quantity (VPE)	10
Length of the packaging	0,31 m
Width of the packaging	0,195 m
Depth of the packaging	0,14 m
Gross weight(VPE)	2,758 kg

### Certificates

---

VDE/ENEC certification	40024796	
EAC certification	BY112.02.01.020 06101	

## Classification system

Classification system	ETIM_6.0
ETIM Class	EC001320

## Technical product data

IEC-amperage	16 A
Amperage acc. UL/CSA (for UL-version)	20 A
Number of poles	4
Voltage acc. EN 60309-2	400 V (50+60 Hz) red
Clock hour position	6 h
Identification colour	Red
RAL-number	3000
Degree of protection (IP)	IP44
Connection system	Screw less terminal
Angle of plug	Straight
Cable entry	Anti-kink sleeve
Material	Plastic

## Dimension sheet

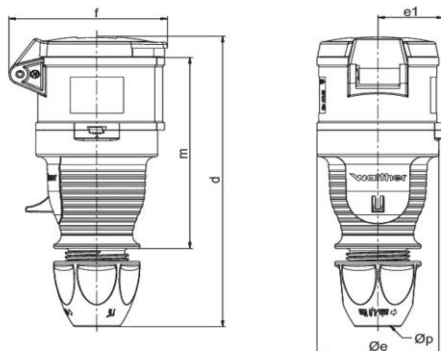

Amp.	16	16	32	32	32
Pole	4	5	3	4	5
d	165-176	165-176	189-199	189-199	189-199
Øe	65	65	72	72	72
e1	35	35	38,5	38,5	38,5
f	77	85	91	91	97
m	114	114	130	130	130
Øp	7,5 - 18,5	7,5 - 18,5	10 - 22,5	10 - 22,5	10 - 22,5