

PRODUCT DATA SHEET

Part number 436304

EAN 4015609020058

Manufacturer WALTHER-WERKE

WEEE-Reg.-Number: DE 22131895

Product description

MONDO wall socket 32A 3P 4h built-in with flush-mounted socket and plaster-compensating flange in pearl white



Similar image

Detailed product description

WALTHER Wall socket 32A 3P 110V 4h IP44

from the MONDO series

made from PA6 material

flush-mounted

in pearl white (RAL 1013)

with flush-mounted socket

and plaster-compensating flange

outer dimensions 90x90



The flat cover allows a low housing height

and is therefore suitable for prestigious areas.

Ordering Information

Order unit	Piece
Customs number	85366990
Net weight	0,361 kg
Packing quantity (VPE)	5
Length of the packaging	0,31 m
Width of the packaging	0,255 m
Depth of the packaging	0,15 m
Gross weight(VPE)	2,001 kg

Certificates

VDE certification	123021	
EAC certification	BY112.02.01.020 06089	

Classification system

Classification system	ETIM_6.0
ETIM Class	EC001318

Technical product data

Current supply	CEE 32 A
Number of poles	3
Voltage acc. EN 60309-2	110 V (50+60 Hz) yellow
Clock hour position	4 h
Identification colour	Yellow
Construction type	Flush mounted socket with UP box
Configuration	Closed cover
Colour	White
RAL-number	1013

Dimension sheet

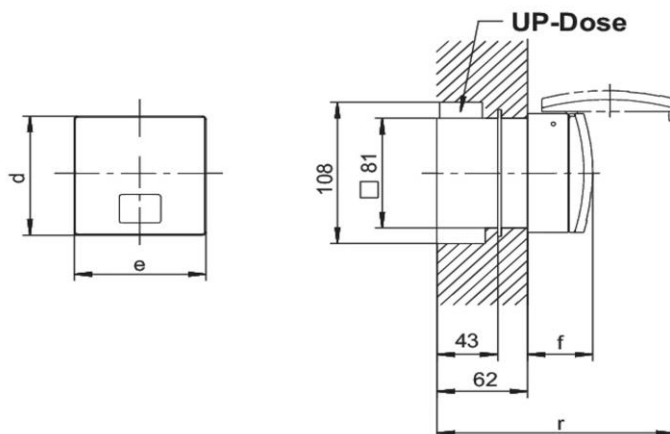

Amp.	32		
Pole	3	4	5
d	90	90	90
e	90	90	90
f	45	45	45
r	104	104	104