

PRODUCT DATA SHEET

Part number 532504

EAN 4015609021994

Manufacturer WALTHER-WERKE

WEEE-Reg.-Number: DE 22131895

Product description

Panel socket angled 32A 5P 4h with flange
 110x110mm



Similar image



Detailed product description

WALTHER Panel socket 32A 5P 110V 4h IP44
 angled
 made from PA6 material
 finger-safe in accordance with BGV A3
 soft transition
 radius from flange to collar
 flange 110x110
 fixing center 90x90

Ordering Information

Order unit	Piece
Customs number	85366990
Net weight	0,259 kg
Packing quantity (VPE)	10
Length of the packaging	0,31 m
Width of the packaging	0,255 m
Depth of the packaging	0,15 m
Gross weight(VPE)	2,786 kg

Certificates

VDE certification	123021	
EAC certification	BY112.02.01.020 06089	

Classification system

Classification system	ETIM_6.0
ETIM Class	EC001317

Technical product data

IEC-amperage	32 A
Amperage acc. UL/CSA (for UL-version)	30 A
Number of poles	5
Voltage acc. EN 60309-2	110 V (50+60 Hz) yellow
Clock hour position	4 h
Identification colour	Yellow
RAL-number	1018
Degree of protection (IP)	IP44
Connection system	Screwed terminal
Angle of plug	Angled
Material	Plastic
Military model	False
Flange size vertical	110 mm
Drill hole distance vertical	90 mm
Flange size horizontal	110 mm
Drill hole distance horizontal	90 mm

Dimension sheet

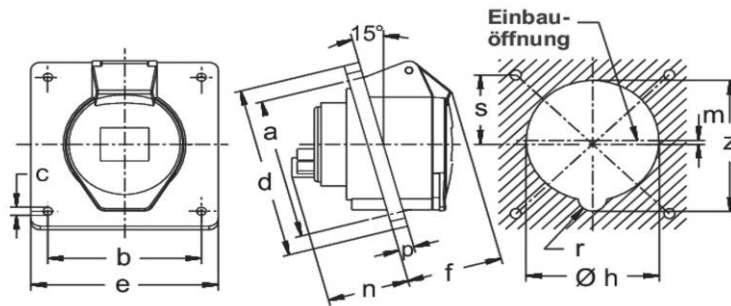

Amp.	16	32	63
Pole	5	5	5
a	90	90	90
b	90	90	90
c	5,5	5,5	6,5
d	110	110	114
e	110	110	114
f	51	56	79
h	70	78	86
m	2	2,5	2,5
n	38	47	64
p	9	9	12
r	7,5	8,5	10
s	45	45	45
z	74	85	94