

## PRODUCT DATA SHEET

---

Part number 579409

---

EAN 4015609022922

Manufacturer WALTHER-WERKE

WEEE-Reg.-Number: DE 22131895

### Product description

---

Waterproof panel socket angled 125A 4P 9h with flange 114x114mm



Product image

### Detailed product description

---

WALTHER Panel socket 125A 4P 230V 9h IP67  
 angled  
 made from PA6 material  
 back-of-hand-proof in accordance with BGV A3  
 soft transition  
 radius from flange to collar  
 flange 114x114  
 fixing center 90x90  
 with multi-contact



### Ordering Information

---

Order unit	Piece
Customs number	85366990
Net weight	1,152 kg
Packing quantity (VPE)	2
Length of the packaging	0,31 m
Width of the packaging	0,195 m
Depth of the packaging	0,14 m
Gross weight(VPE)	2,452 kg

## Certificates

---

VDE certification	123029	
UL certification	No. E83342	
EAC certification	BY112.02.01.020 06089	

## Classification system

---

Classification system	ETIM_6.0
ETIM Class	EC001317

## Technical product data

---

IEC-amperage	125 A
Amperage acc. UL/CSA (for UL-version)	100 A
Number of poles	4
Voltage acc. EN 60309-2	230 V (50+60 Hz) blue
Clock hour position	9 h
Identification colour	Blue
RAL-number	5002
Degree of protection (IP)	IP67
Connection system	Screwed terminal
Angle of plug	Angled
Material	Plastic
Military model	False
Flange size vertical	114 mm
Drill hole distance vertical	90 mm
Flange size horizontal	114 mm
Drill hole distance horizontal	90 mm

## Dimension sheet

---

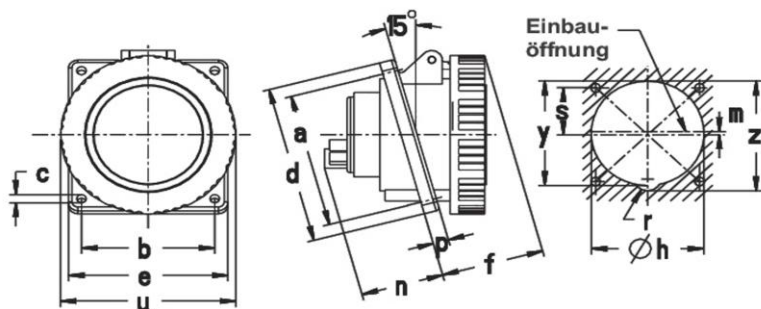

Amp.	125		
Pole	3	4	5
a	90	90	90
b	90	90	90
c	6,5	6,5	6,5
d	114	114	114
e	114	114	114
f	94	94	94
h	90	90	88
m	-/-	8	8
n	75	75	75
p	12	12	12
r	8	8	9,5
s	-/-	45	45
u	130	130	130
y	96	96	96
z	102	102	104