

PRODUCT DATA SHEET

Part number 579504

EAN 4015609022953

Manufacturer WALTHER-WERKE

WEEE-Reg.-Number: DE 22131895

Product description

Waterproof panel socket angled 125A 5P 4h with flange 114x114mm



Product image



Detailed product description

WALTHER Panel socket 125A 5P 110V 4h IP67
 angled
 made from PA6 material
 back-of-hand-proof in accordance with BGV A3
 soft transition
 radius from flange to collar
 flange 114x114
 fixing center 90x90
 with multi-contact

Ordering Information

Order unit	Piece
Customs number	85366990
Net weight	1,316 kg
Packing quantity (VPE)	2
Length of the packaging	0,31 m
Width of the packaging	0,195 m
Depth of the packaging	0,14 m
Gross weight(VPE)	2,78 kg

Certificates

VDE certification	123029	
UL certification	No. E83342	
EAC certification	BY112.02.01.020 06089	

Classification system

Classification system	ETIM_6.0
ETIM Class	EC001317

Technical product data

IEC-amperage	125 A
Amperage acc. UL/CSA (for UL-version)	100 A
Number of poles	5
Voltage acc. EN 60309-2	110 V (50+60 Hz) yellow
Clock hour position	4 h
Identification colour	Yellow
RAL-number	1018
Degree of protection (IP)	IP67
Connection system	Screwed terminal
Angle of plug	Angled
Material	Plastic
Military model	False
Flange size vertical	114 mm
Drill hole distance vertical	90 mm
Flange size horizontal	114 mm
Drill hole distance horizontal	90 mm

Dimension sheet

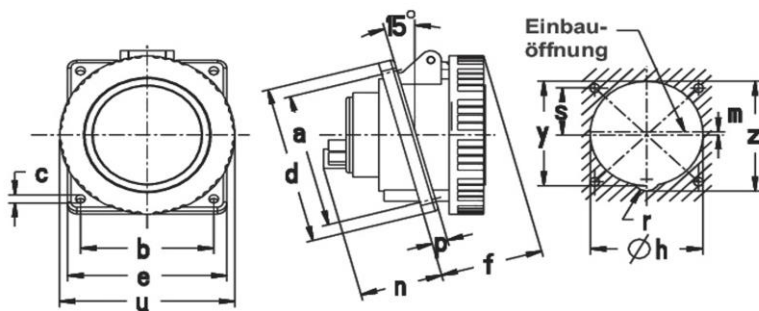

Amp.	125		
Pole	3	4	5
a	90	90	90
b	90	90	90
c	6,5	6,5	6,5
d	114	114	114
e	114	114	114
f	94	94	94
h	90	90	88
m	-/-	8	8
n	75	75	75
p	12	12	12
r	8	8	9,5
s	-/-	45	45
u	130	130	130
y	96	96	96
z	102	102	104