

PRODUCT DATA SHEET

Part number	5E9409
EAN	4015609065691
Manufacturer	WALTHER-WERKE
WEEE-Reg.-Nr:	DE 22131895

Product description

CEE High current panel socket angled 400A 4P 9h IP67 B-Line with screw terminal



Product image

Detailed product description

WALTHER CEE High current panel socket angled with screw terminal
 400A 4P 9h IP67 230V ~
 enclosure made from aluminium
 with high temperature resisting contact carriers
 B-Line

Ordering information

order unit	Piece
customs number	85366990
net weight	10.3 kg
packing quantity(VPE)	1
length of the packaging	0.462 m
width of the packaging	0.24 m
depth of the packaging	0.242 m
gross weight(VPE)	10.3 kg

Conformities

CE conformity	√
RoHS directive	2011/65/EU

Classification system

classification system	ETIM_7.0
ETIM Class	EC001322

Technical product data

construction type	equipment mounted socket outlet
amperage	400 A
rated current	450 A
rated frequency	50/60 Hz
number of poles	4
clock hour position	9 h
voltage	230 V
rated voltage	1000 V
test voltage (1min/50Hz)	4000 V
degree of protection (IP)	IP67
mechanical protection	IK10
strain energy	20 Joule
load-carrying capacity	2 t
ambient temperature	-40 - 100 °C
min. connection cross section, rope EN 60228 class 5	70 mm ²
max. connection cross section, rope EN 60228 class 5	240 mm ²
max. connection cross section pilot, wire EN 60228 class 5	4 mm ²
cable diameter	34-66 mm
cable diameter - separate pilot cable	8-15 mm
contact screws	M10
tightening torque contact screws	16 Nm
tightening torque pilot contacts	1.4 Nm

Dimension sheet

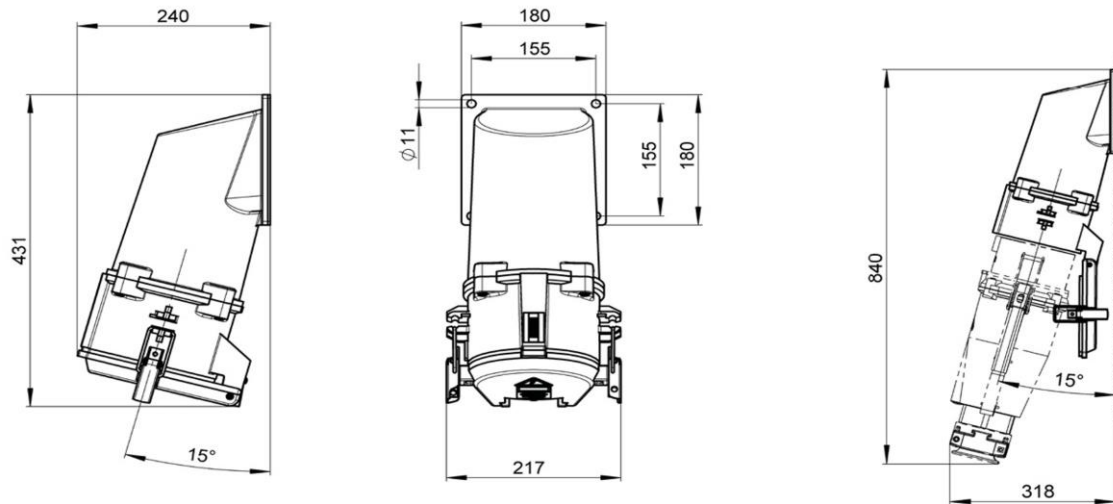

Kabel ohne Pilotkontakte

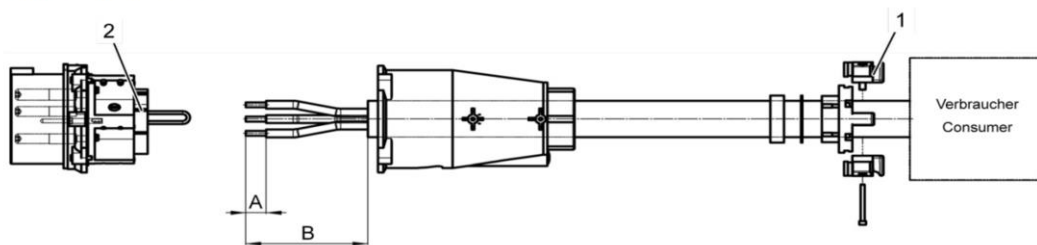

1 Kabelverschraubung

2 Kontaktbuchsen

1.	C-Line	B-Line
Länge	200 A – 250 A	250 A - 400 A
A	30 mm	60 mm
B	150 mm	200 mm