

PRODUCT DATA SHEET

Part number 636404

EAN 4015609166978

Manufacturer WALTHER-WERKE

WEEE-Reg.-Number: DE 22131895

Product description

Wall appliance inlet for internal fixing 32A 4P 4h with two knock-out cable entries both on top and bottom and knock-out floor entry



Similar image

Detailed product description

WALTHER Wall appliance inlet 32A 4P 110V 4h IP44
 made from PA6 material
 for internal fixing
 with two cable entries both top and bottom
 and one floor entry (knock-out)

Ordering Information

Order unit	Piece
Customs number	85366990
Net weight	0,372 kg
Packing quantity (VPE)	5
Length of the packaging	
Width of the packaging	
Depth of the packaging	
Gross weight(VPE)	1,86 kg

Certificates

VDE certification 123022



Classification system

Classification system	ETIM_6.0
ETIM Class	EC001319

Technical product data

IEC-amperage	32 A
Amperage acc. UL/CSA (for UL-version)	30 A
Number of poles	4
Voltage acc. EN 60309-2	110 V (50+60 Hz) yellow
Clock hour position	4 h
Identification colour	Yellow
RAL-number	1018
Degree of protection (IP)	IP44
Connection system	Screwed terminal
Connection type	Wall mounted plug
Angle of plug	Angled
Material	Plastic

Dimension sheet

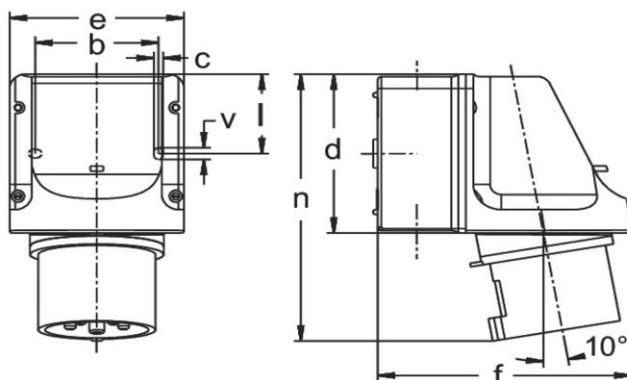

Amp.	16		32		
Pole	4	5	3	4	5
b	66,5	66,5	66,5	66,5	66,5
c	5	5	5	5	5
d	96	96	96	96	96
e	95	95	95	95	95
f	140	140	140	140	140
l	47,5	47,5	47,5	47,5	47,5
n	151	151	160	160	160
v	7	7	7	7	7
M	20/25	20/25	20/25	20/25	20/25