

## PRODUCT DATA SHEET

---

Part number 636509

---

EAN 4015609128556

Manufacturer WALTHER-WERKE

WEEE-Reg.-Number: DE 22131895

### Product description

---

Wall appliance inlet for internal fixing 32A 5P 9h with two knock-out cable entries both on top and bottom and knock-out floor entry



Similar image

### Detailed product description

---

WALTHER Wall appliance inlet 32A 5P 230V 9h IP44  
 made from PA6 material  
 for internal fixing  
 with two cable entries both top and bottom  
 and one floor entry (knock-out)

### Ordering Information

---

Order unit	Piece
Customs number	85366990
Net weight	0,399 kg
Packing quantity (VPE)	5
Length of the packaging	
Width of the packaging	
Depth of the packaging	
Gross weight(VPE)	1,995 kg

### Certificates

---

VDE certification 123022



## Classification system

Classification system	ETIM_6.0
ETIM Class	EC001319

## Technical product data

IEC-amperage	32 A
Amperage acc. UL/CSA (for UL-version)	30 A
Number of poles	5
Voltage acc. EN 60309-2	230 V (50+60 Hz) blue
Clock hour position	9 h
Identification colour	Blue
RAL-number	5002
Degree of protection (IP)	IP44
Connection system	Screwed terminal
Connection type	Wall mounted plug
Angle of plug	Angled
Material	Plastic

## Dimension sheet

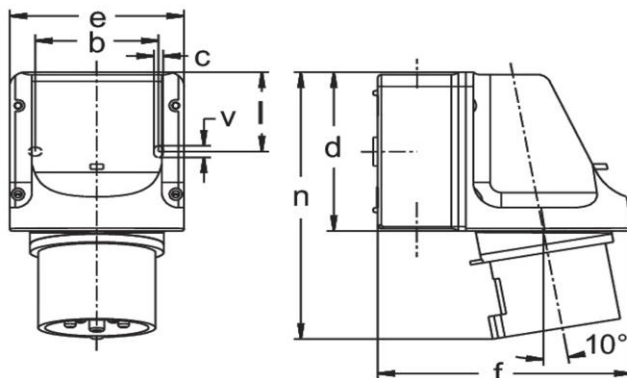

Amp.	16		32		
Pole	4	5	3	4	5
b	66,5	66,5	66,5	66,5	66,5
c	5	5	5	5	5
d	96	96	96	96	96
e	95	95	95	95	95
f	140	140	140	140	140
l	47,5	47,5	47,5	47,5	47,5
n	151	151	160	160	160
v	7	7	7	7	7
M	20/25	20/25	20/25	20/25	20/25