

PRODUCT DATA SHEET

Part number 639504

EAN 4015609165940

Manufacturer WALTHER-WERKE

WEEE-Reg.-Number: DE 22131895

Product description

Waterproof panel appliance inlet angled 32A 5P
 4h with screwed flange housing 75x90mm



Product image





Detailed product description

WALTHER Panel appliance inlet 32A 5P 110V 4h IP67
 angled
 made from PA6 material
 with screwed flange housing
 flange 75x90
 fixing center 45x78

Ordering Information

Order unit	Piece
Customs number	85366990
Net weight	0,295 kg
Packing quantity (VPE)	5
Length of the packaging	0,31 m
Width of the packaging	0,255 m
Depth of the packaging	0,15 m
Gross weight(VPE)	1,671 kg

Certificates

VDE certification	123022	
UL certification	No. E83342	
UL certification	No. E188992	
EAC certification	BY112.02.01.020 06091	

Classification system

Classification system	ETIM_6.0
ETIM Class	EC001319

Technical product data

IEC-amperage	32 A
Amperage acc. UL/CSA (for UL-version)	30 A
Number of poles	5
Voltage acc. EN 60309-2	110 V (50+60 Hz) yellow
Clock hour position	4 h
Identification colour	Yellow
RAL-number	1018
Degree of protection (IP)	IP67
Connection system	Screwed terminal
Connection type	Built-up device plug
Angle of plug	Angled
Material	Plastic

Dimension sheet

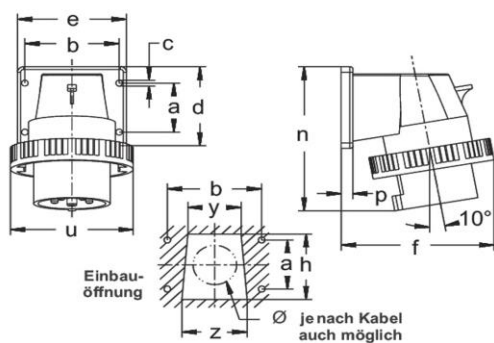

Amp.	16			32			63		
Pole	3	4	5	3	4	5	3	4	5
a	30	40	40	45	45	45	90	90	90
b	55	68	68	78	78	78	90	90	90
c	5,5	5,5	5,5	5,5	5,5	5,5	6,2	6,2	6,2
d	52	66	66	75	75	75	114	114	114
e	65	80	80	90	90	90	114	114	114
f	81	99	103	111	111	117	129	129	129
h	38	52	52	60	60	60	70	70	70
n	98	111	113	131	131	131	184	184	184
p	9,5	9,5	9,5	9,5	9,5	9,5	6	6	6
u	72	81	88	96	96	103	110	110	110
y	30	38	38	44	44	44	56	56	56
z	36	46	46	54	54	54	65	65	65