

PRODUCT DATA SHEET

Part number 668309

EAN 4015609024902

Manufacturer WALTHER-WERKE

WEEE-Reg.-Number: DE 22131895

Product description

Waterproof wall appliance inlet for external fixing
 63A 3P 9h with one top cable entry, non-nickel-
 plated contacts and pilot contact



Product image

Detailed product description

WALTHER Wall appliance inlet 63A 3P 400V 9h IP67
 made from PA6 material
 with non-nickel-plated contacts
 with with one top cable entry
 and pilot contact
 for external fixing

Ordering Information

Order unit	Piece
Customs number	85366990
Net weight	0,825 kg
Packing quantity (VPE)	2
Length of the packaging	
Width of the packaging	
Depth of the packaging	
Gross weight(VPE)	1,65 kg

Classification system

Classification system	ETIM_6.0
ETIM Class	EC001319

Technical product data

IEC-amperage	63 A
Amperage acc. UL/CSA (for UL-version)	60 A
Number of poles	3
Voltage acc. EN 60309-2	400 V (50+60 Hz) red
Clock hour position	9 h
Identification colour	Red
RAL-number	3000
Degree of protection (IP)	IP67
Connection system	Screwed terminal
Connection type	Wall mounted plug
Angle of plug	Angled
Material	Plastic

Dimension sheet

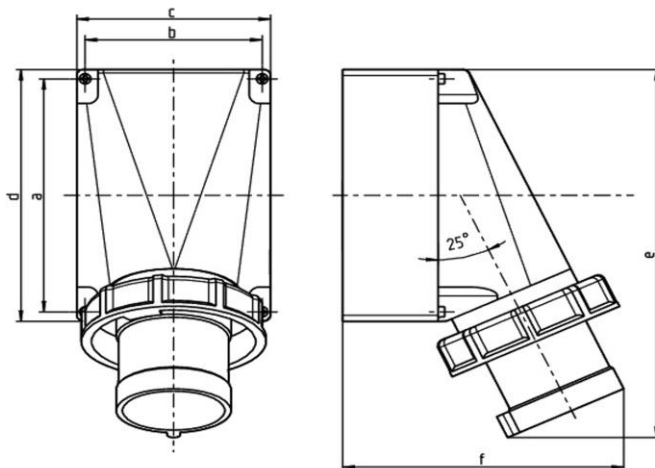

Amp.	63		
Pole	3	4	5
a	136	120	120
b	104	104	104
c	118	118	118
d	170	170	170
e	250	250	250
f	171	171	171
M	40	40	40