

PRODUCT DATA SHEET

Part number 669509

EAN 4015609025138

Manufacturer WALTHER-WERKE

WEEE-Reg.-Number: DE 22131895

Product description

Waterproof panel appliance inlet angled 63A 5P 9h with screwed flange housing 114x114mm and pilot contact



Product image



Detailed product description

WALTHER Panel appliance inlet 63A 5P 230V 9h IP67
 angled
 made from PA6 material
 with screwed flange housing
 and pilot contact
 flange 114x114
 fixing center 90x90

Ordering Information

Order unit	Piece
Customs number	85366990
Net weight	0,613 kg
Packing quantity (VPE)	5
Length of the packaging	0,31 m
Width of the packaging	0,255 m
Depth of the packaging	0,15 m
Gross weight(VPE)	3,261 kg

Certificates

VDE certification	40000706	
UL certification	No. E83342	
EAC certification	BY112.02.01.020 06091	

Classification system

Classification system	ETIM_6.0
ETIM Class	EC001319

Technical product data

IEC-amperage	63 A
Amperage acc. UL/CSA (for UL-version)	60 A
Number of poles	5
Voltage acc. EN 60309-2	230 V (50+60 Hz) blue
Clock hour position	9 h
Identification colour	Blue
RAL-number	5002
Degree of protection (IP)	IP67
Connection system	Screwed terminal
Connection type	Built-up device plug
Angle of plug	Angled
Material	Plastic

Dimension sheet

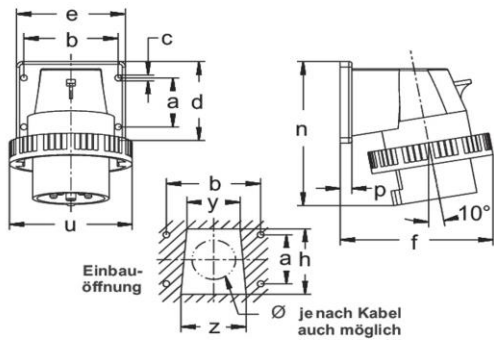

Amp.	16			32			63		
Pole	3	4	5	3	4	5	3	4	5
a	30	40	40	45	45	45	90	90	90
b	55	68	68	78	78	78	90	90	90
c	5,5	5,5	5,5	5,5	5,5	5,5	6,2	6,2	6,2
d	52	66	66	75	75	75	114	114	114
e	65	80	80	90	90	90	114	114	114
f	81	99	103	111	111	117	129	129	129
h	38	52	52	60	60	60	70	70	70
n	98	111	113	131	131	131	184	184	184
p	9,5	9,5	9,5	9,5	9,5	9,5	6	6	6
u	72	81	88	96	96	103	110	110	110
y	30	38	38	44	44	44	56	56	56
z	36	46	46	54	54	54	65	65	65