

## PRODUCT DATA SHEET

---

Part number	6A1406
EAN	4015609063314
Manufacturer	WALTER-WERKE
WEEE-Reg.-Nr:	DE 22131895

### Product description

---

CEE High current panel appliance inlet angled  
 200A 4P 6h IP67 C-Line with screw terminal



Product image

### Detailed product description

---

WALTER CEE High current panel appliance inlet angled  
 with screw terminal  
 200A 4P 6h IP67 400V ~  
 enclosure made from aluminium  
 with high temperature resisting contact carriers  
 C-Line

### Ordering information

---

order unit	Piece
customs number	85366990
net weight	4.2 kg
packing quantity(VPE)	1
length of the packaging	0.462 m
width of the packaging	0.24 m
depth of the packaging	0.242 m
gross weight(VPE)	4.2 kg

### Conformities

---

CE conformity	√
RoHS directive	2011/65/EU

## Classification system

classification system	ETIM_7.0
ETIM Class	EC001322

## Technical product data

construction type	device plug
amperage	200 A
rated current	250 A
rated frequency	50/60 Hz
number of poles	4
clock hour position	6 h
voltage	400 V
rated voltage	1000 V
test voltage (1min/50Hz)	4000 V
degree of protection (IP)	IP67
mechanical protection	IK10
strain energy	20 Joule
ambient temperature	-40 - 100 °C
min. connection cross section, rope EN 60228 class 5	35 mm <sup>2</sup>
max. connection cross section, rope EN 60228 class 5	150 mm <sup>2</sup>
max. connection cross section pilot, wire EN 60228 class 5	4 mm <sup>2</sup>
cable diameter	34-66 mm
cable diameter - separate pilot cable	5-10 mm
contact screws	M8
tightening torque contact screws	8 Nm
tightening torque pilot contacts	1.4 Nm
chemical resistance	
- acetic acid	√
- citric acid	√
- lactic acid	√
- sodium hydroxide	√
- isopropanol	√
- methanol	√
- ethanol	√
- hydrogen peroxide	√
- n-hexane	√
- toluene	√

- iso-octane	✓
- acetone	✓
- diethyl ether	✓
- SAE10W40 multigrade oil	✓
- diesel oil	✓
- ethyl acetate	✓

## Dimension sheet

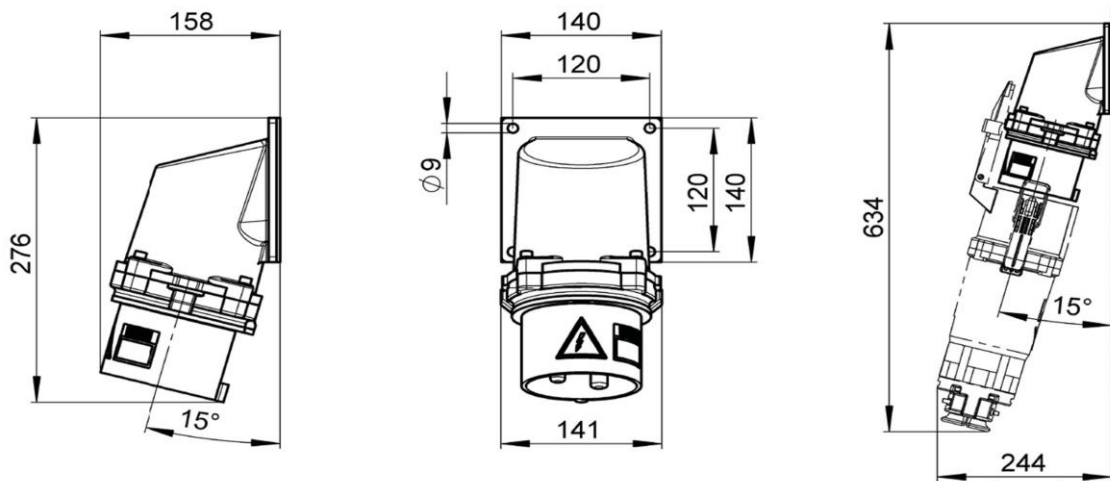

### Kabel ohne Pilotkontakte

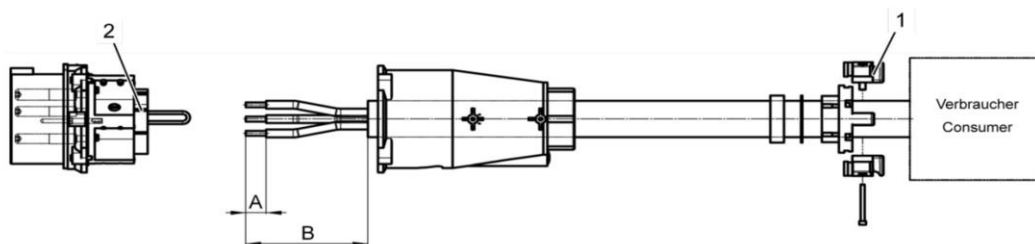

1 Kabelverschraubung

2 Kontaktbuchsen

1.		C-Line	B-Line
Länge		200 A – 250 A	250 A - 400 A
A		30 mm	60 mm
B		150 mm	200 mm