

PRODUCT DATA SHEET

| | |
|---------------|---------------|
| Part number | 6B1409 |
| EAN | 4015609065387 |
| Manufacturer | WALTHER-WERKE |
| WEEE-Reg.-Nr: | DE 22131895 |

Product description

CEE High current panel appliance inlet angled
 250A 4P 9h IP67 C-Line with screw terminal



Product image

Detailed product description

WALTHER CEE High current panel appliance inlet angled
 with screw terminal
 250A 4P 9h IP67 230V ~
 enclosure made from aluminium
 with high temperature resisting contact carriers
 C-Line

Ordering information

| | |
|-------------------------|----------|
| order unit | Piece |
| customs number | 85366990 |
| net weight | 4.2 kg |
| packing quantity(VPE) | 1 |
| length of the packaging | 0.462 m |
| width of the packaging | 0.24 m |
| depth of the packaging | 0.242 m |
| gross weight(VPE) | 4.2 kg |

Conformities

| | |
|----------------|------------|
| CE conformity | √ |
| RoHS directive | 2011/65/EU |

Classification system

| | |
|-----------------------|----------|
| classification system | ETIM_7.0 |
| ETIM Class | EC001322 |

Technical product data

| | |
|--|---------------------|
| construction type | device plug |
| amperage | 250 A |
| rated current | 285 A |
| rated frequency | 50/60 Hz |
| number of poles | 4 |
| clock hour position | 9 h |
| voltage | 230 V |
| rated voltage | 1000 V |
| test voltage (1min/50Hz) | 4000 V |
| degree of protection (IP) | IP67 |
| mechanical protection | IK10 |
| strain energy | 20 Joule |
| ambient temperature | -40 - 100 °C |
| min. connection cross section, rope EN 60228 class 5 | 35 mm ² |
| max. connection cross section, rope EN 60228 class 5 | 150 mm ² |
| max. connection cross section pilot, wire EN 60228 class 5 | 4 mm ² |
| cable diameter | 34-66 mm |
| cable diameter - separate pilot cable | 5-10 mm |
| contact screws | M8 |
| tightening torque contact screws | 8 Nm |
| tightening torque pilot contacts | 1.4 Nm |
| chemical resistance | |
| - acetic acid | √ |
| - citric acid | √ |
| - lactic acid | √ |
| - sodium hydroxide | √ |
| - isopropanol | √ |
| - methanol | √ |
| - ethanol | √ |
| - hydrogen peroxide | √ |
| - n-hexane | √ |
| - toluene | √ |

| | |
|---------------------------|---|
| - iso-octane | ✓ |
| - acetone | ✓ |
| - diethyl ether | ✓ |
| - SAE10W40 multigrade oil | ✓ |
| - diesel oil | ✓ |
| - ethyl acetate | ✓ |

Dimension sheet

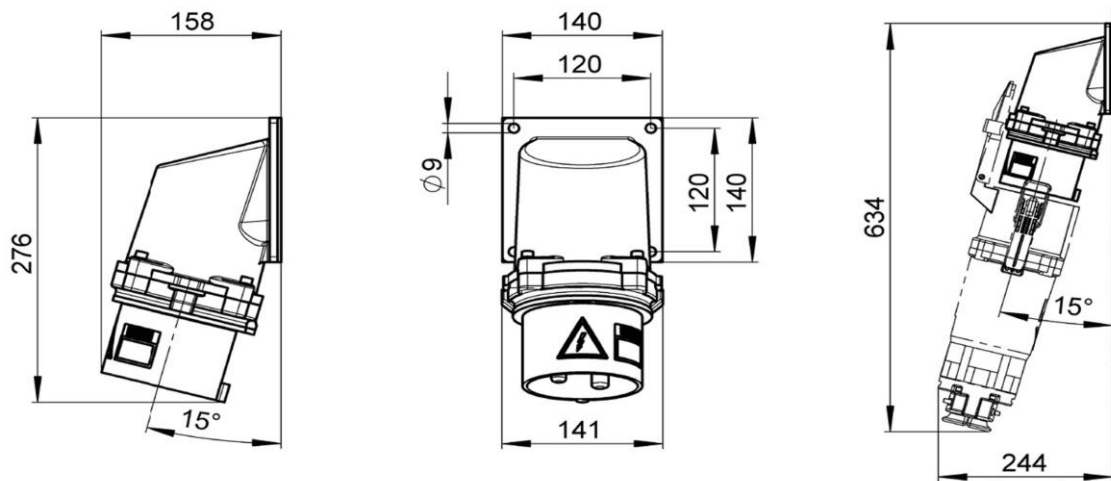

Kabel ohne Pilotkontakte

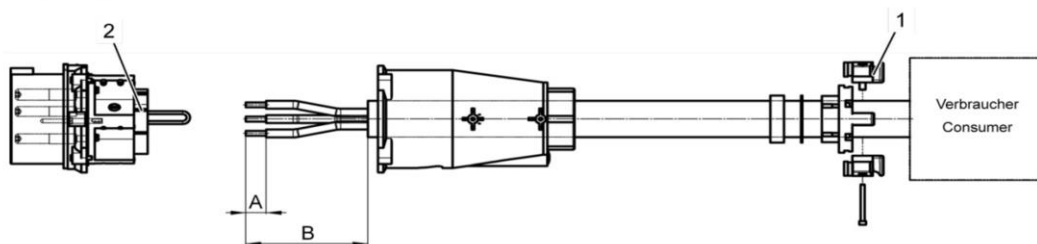

1 Kabelverschraubung

2 Kontaktbuchsen

| 1. | | C-Line | B-Line |
|-------|--|---------------|---------------|
| Länge | | 200 A – 250 A | 250 A - 400 A |
| A | | 30 mm | 60 mm |
| B | | 150 mm | 200 mm |