

## PRODUCT DATA SHEET

---

Part number	6C1407
EAN	4015609065004
Manufacturer	WALTHER-WERKE
WEEE-Reg.-Nr:	DE 22131895

### Product description

---

CEE High current panel appliance inlet angled  
 250A 4P 7h IP67 B-Line with screw terminal



Product image

### Detailed product description

---

WALTHER CEE High current panel appliance inlet angled  
 with screw terminal  
 250A 4P 7h IP67 500V ~  
 enclosure made from aluminium  
 with high temperature resisting contact carriers  
 B-Line

### Ordering information

---

order unit	Piece
customs number	85366990
net weight	9.8 kg
packing quantity(VPE)	1
length of the packaging	0.462 m
width of the packaging	0.24 m
depth of the packaging	0.242 m
gross weight(VPE)	9.8 kg

### Conformities

---

CE conformity	√
RoHS directive	2011/65/EU

## Classification system

---

classification system	ETIM_7.0
ETIM Class	EC001322

## Technical product data

---

construction type	device plug
amperage	250 A
rated current	315 A
rated frequency	50/60 Hz
number of poles	4
clock hour position	7 h
voltage	500 V
rated voltage	1000 V
test voltage (1min/50Hz)	4000 V
degree of protection (IP)	IP67
mechanical protection	IK10
strain energy	20 Joule
load-carrying capacity	2 t
ambient temperature	-40 - 100 °C
min. connection cross section, rope EN 60228 class 5	70 mm <sup>2</sup>
max. connection cross section, rope EN 60228 class 5	240 mm <sup>2</sup>
max. connection cross section pilot, wire EN 60228 class 5	4 mm <sup>2</sup>
cable diameter	34-66 mm
cable diameter - separate pilot cable	8-15 mm
contact screws	M10
tightening torque contact screws	16 Nm
tightening torque pilot contacts	1.4 Nm

## Dimension sheet

---

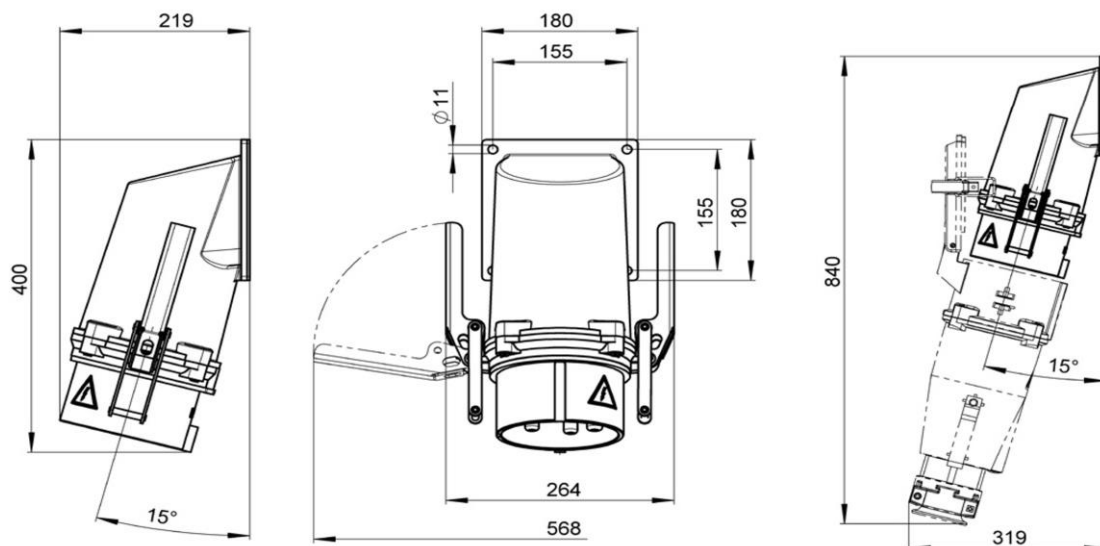

**Kabel ohne Pilotkontakte**

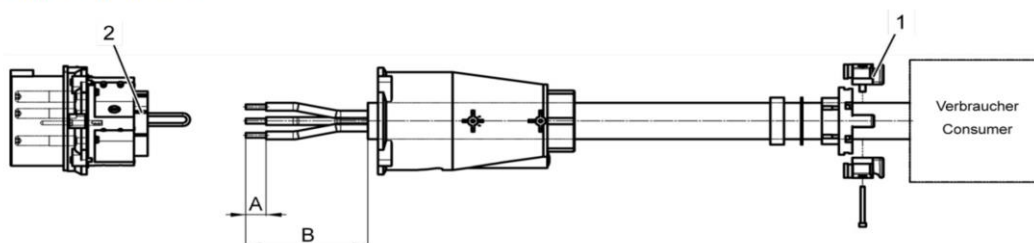

1 Kabelverschraubung

2 Kontaktbuchsen

1.	C-Line	B-Line
<b>Länge</b>	<b>200 A – 250 A</b>	<b>250 A - 400 A</b>
A	30 mm	60 mm
B	150 mm	200 mm